

HYDRAULISCHE MAGNETEN

# HMG SERIE

6 MODELLE HYDRAULISCHE MAGNETEN VON 780 BIS ZU 2.500 KG FÜR BAGGER 10 BIS 60 TONNEN

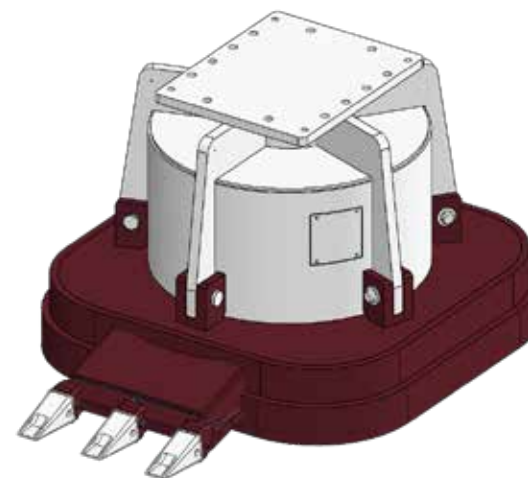







6 MODELLE HYDRAULISCHE MAGNETEN **MIT ZÄHNEN** VON 950 BIS ZU 3.000 KG FÜR BAGGER 10 BIS 60 TONNEN



Ohne Zähne			HMG-850	HMG-950	HMG-1100	HMG-1150	HMG-1300	HMG-1500
(1)	Baggerklasse	T.	10 - 14	14 - 17	19 - 23	20 - 25	26 - 32	30 - 60
	Gewicht	Kg.	780	960	1100	1200	1880	2500
	Durchmesser	mm.	850	950	1050	1130	1250	1500
	Arbeitsdruck	Bar	180	180	180	180	180	180
	Ölvolumenstrom	L/min.	38 - 200	50 - 200	70 - 200	80 - 200	100 - 200	100 - 200
	Leistung	Kw.	3.5	4.5	5.5	6	7	12
	Elektrische Spannung	Volt.	230	230	230	230	230	230
	Loser Schrott	Kg.	250	350	450	650	900	1500
	Massiver Stahlplatte	Kg.	3500	3500	7000	11000	12000	20000

(1) Empfohlene Bagger / Anbauteil Kombination

HMG-T Ausgestattet mit wechselbaren Zähnen

Mit Zähen		HMG-T850	HMG-T950	HMG-T1100	HMG-T1150	HMG-T1300	HMG-T1500
 (1) Baggerklasse	T.	10 - 14	14 - 17	19 - 23	20 - 25	26 - 32	34 - 60
 Gewicht	Kg.	950	1130	1315	1400	2100	3000
 Durchmesser	mm.	850	950	1050	1130	1250	1500
 Arbeitsdruck	Bar	180	180	180	180	180	180
 Ölvolumenstrom	L/min.	38 - 200	50 - 200	70 - 200	80 - 200	100 - 200	100 - 200
 Leistung	Kw.	3.5	4.5	5.5	6	7	12
 Elektrische Spannung	Volt.	230	230	230	230	230	230
 Loser Schrott	Kg.	250	350	450	650	900	1500
 Massiver Stahlplatte	Kg.	3500	3500	7000	11000	12000	20000

